

Hard Disk Drive Specifications

Ultrastar 10K300 – 300/ 147/ 73/ 36

(SCSI Interface)

Models HUS103030FL3600 :(300GB/68pin)
Models HUS103014FL3600 :(147GB/68pin)
Models HUS103073FL3600 :(73GB/68pin)
Models HUS103036FL3600 :(36GB/68pin)
Models HUS103030FL3800 :(300GB/80pin)
Models HUS103014FL3800 :(147GB/80pin)
Models HUS103073FL3800 :(73GB/80pin)
Models HUS103036FL3800 :(36GB/80pin)

Read and follow all instructions and cautions for safety described in this document before using the drive.
It is recommended that this manual is kept at a proper location for quick reference.

Hitachi Global Storage Technologies

© 2003, Hitachi Global Storage Technologies. All Rights Reserved.

Drawing No.	Sheet No.	Revision	6
K6610091	1/43	2005/2/23	

REVISION CONTROL

Remarks

AD: Addition , CH: Change ,CR: Correction ,DL: Deletion

Rev.	Date	Signature	Page	Description	Remarks
0	2003/8/5	DWN : O,Suzuki CHKD: T,Nakazawa APPD: T,Nakazawa	All	First Issuance	
1	2003/12/19	DWN : O,Suzuki CHKD: T,Nakazawa APPD: T,Nakazawa	9 10 10 14 16	It updated to new information Table 3.1 Seek time (average) Table 3.1 Power requirement Table 3.3 Fig 4.1	CH CH AD AD AD
2	2004/2/24	DWN : O,Suzuki CHKD: T,Nakazawa APPD: T,Nakazawa	All 3 9 9 10 10 10,14 11 14	PRELIMINARY UL1950,CAN/CSA RRL mark for Korean EMC UL1950,CAN/CSA Byte/sector (514,522) Byte/sector (1024) Note 15 (DC Current Value) Life (See section 7.6) Note 13 (Logical Block Address)	DL CR CH CR AD DL AD CR CR
3	2004/2/26	DWN : O,Suzuki CHKD: T,Nakazawa APPD: T,Nakazawa	16	Fig4.1	CR
4	2004/8/17	DWN : O,Suzuki CHKD: T,Nakazawa APPD: T,Nakazawa	10 14 14	Note15 Note14 (Table3.3) Note15	CH CR CH
5	2004/9/22	DWN : O,Suzuki CHKD: T,Nakazawa APPD: T,Nakazawa	28	8.4.8	DL
6	2005/2/23	DWN : H,Takeda CHKD:T,Nakazawa APPD:T,Nakazawa	10/14 21	Note Tagged command queuing	AD CH

Drawing No.	Sheet No.	Revision	6
K6610091	2/43	2005/2/23	



To use this product safely

Read and follow all instructions and cautions described in this chapter before using the drive. It is recommended that this manual is kept at a proper location for quick reference. The description related to safety in this chapter may be changed without notice.

Influence for environment

Although this product emits electro-magnetic field, it will be found to be in compliance with the EMI regulations such as VCCI class B, FCC Part 15 class B. However, anything other than this product, such as an interface cable, is excluded. Therefore, the following cases require a system side improvement.

- (1) Disturbance of operations of other products or equipment
- (2) Disturbance caused by other product, such as cabling, to operations of other products or equipment.

Do not change the condition of the drive, excluding the change admitted by Hitachi.

Violating above-mentioned precautions will void any warranties of the HDD.

Please read and understand the following explanation for safety.

General cautions for safety

- 0.1.1 When handling the drive, follow all instructions and cautions described in this manual and the packing specification manual.
- 0.1.2 The safety instructions in this manual are thoroughly considered, but unexpected situations can occur. Not only follow the instructions in this manual, but also be careful for the safety by yourself.
- 0.1.3 Do not convert or change the drive. Convert or change of the drive will void any warranties.
- 0.1.4 It is customer's responsibility to assure the actual system in which the drive is installed meets the appropriate safety regulation. However the drive itself is found to be compliance with the following standards:

- UL 60950 3rd Edition
- CAN/CSA-C22.2 No.60950
- IEC60950: 1991
- EN60950: 1992
- FCC Part15 Class B, VCCI Class B
- EN55022: 1998, Class B (CE Mark)
- AS/NZS 3548: 1995, Class B (C-tick)
- CNS13438/C6357, Class B (BSMI)
- RRL mark for Korean EMC

Headline of safety caution

Safety instructions and cautions are indicated as the following head line which means as follows.

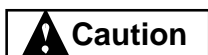

This symbol indicates that potential danger may exist which may cause slight or medium grade bodily injury if safety instructions are not followed.

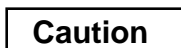

This symbol indicates that potential danger may exist which may cause damage to the product or to the neighboring property if safety instructions are not followed.

Drawing No.	Sheet No.	Revision	6
K6610091	3/43	2005/2/23	

To use this product safely (Continued)

Followings are the cautions and contents described in this manual.

Items of indicating  **Caution** :

- Safety cautions for this product Page 4

Items of indicating  **Caution** :

- Safety cautions for this product Page 4-5
- Spindle Start and Stop Page 16
- Mounting of the drive Page 24
- Reliability temperature Page 26
- Precautions for handling Page 27

Safety cautions for this product

Caution

- 0.2.1 This product is not authorized for use in life support devices or other applications which pose a significant risk of personal injury.
- 0.2.2 Handle the drive with care not to suffer bodily injury caused by hitting the edge of the frame or accidental dropping of the drive.
- 0.2.3 Since the drive uses glass media for the disk platter, opening of HDA may cause bodily injury. Warranty void in case of opened HDA or any broken HDA seals. Do not open the HDA or break any HDA seals.
- 0.2.4 Temperature of the drive may become more than 50°C. Handle the drive carefully not to get burned.

Caution

- 0.2.5 To prevent data from being lost due to an unexpected fatal error, data back up is required.
- 0.2.6 If a foreign conductive substance (metallic powder, fluid, etc.) adheres to active metal of the drive (Print pattern, component lead, etc. on Printed Circuit Board (PCB)), it may cause catastrophic failures. Customer should protect the drive from the above condition.
- 0.2.7 Improper insertion of connector or wrong jumper setting may cause catastrophic failures. Referring to this manual prior to the connector insertion or jumper setting can help insure correct insertion.
- 0.2.8 Follow the environmental conditions and power requirement described in this manual. If violating these specifications, the drive failure may occur.
- 0.2.9 Protect the drive against Electro Static Discharge (ESD) during handling.
- 0.2.10 If storage period becomes long after unpacking, supply power to the drive and rotate the disks 8 minutes or more. This operation shall be executed every 3 months.(Recommendation)

Drawing No.	Sheet No.	Revision	6
K6610091	4/43	2005/2/23	



To use this product safely (Continued)

Caution

- 0.2.11 Protect the drive against shocks with the corrugated board and cushioning material provided by the manufacturer, or with Hitachi Approved containers.
- 0.2.12 When mounting the drive, use the size of screws and the torque recommended in this manual. If non-recommended size of screws and torque are used, it may cause catastrophic failures.
- 0.2.13 Do not press top cover and bottom PCB of the drive. It may cause catastrophic failures.
- 0.2.14 Read and follow all instructions and cautions described on the top cover of the drive, and in the chapter, Precautions for handling, in this manual.
- 0.2.15 In case of fluctuations in the DC power (spikes, momentary shut off, etc.), the data being recorded or to be recorded from buffer memory are not assured.
- 0.2.16 If you find a smoke or a bad smell generating from the product, stop using it, turn the power off, and see your sales contact.

Warranty and Limited Liability

This product is sold with a limited warranty and specific remedies are available to the original purchaser in the event the product fails to conform to the limited warranty. Hitachi GST liability may be further limited in accordance with its sales contact.

In general, Hitachi GST shall not be responsible for product damages caused by natural disasters, fire, static discharge, misuse, abuse, neglect, improper handling or installation, unauthorized repair, alteration, or accident. In no event will Hitachi GST be liable for loss of data stored on product.

Hitachi GST shall not be liable for any special, incidental or consequential damages, even if informed of the possibility thereof in advance.

Please see your sales contact for a complete statement of warranty rights, remedies and limitation of liability.

Drawing No.	Sheet No.	Revision	6
K6610091	5/43	2005/2/23	

TABLE OF CONTENTS

Chapter	Page
▲ To use this product safely.	3
1 Features.....	8
2 Standards and Related Documents	9
3 Description.....	10
3.1 Characteristics	10
3.2 Environmental conditions and reliability	11
4 DC power Interface.....	15
4.1 DC Power Requirement	15
4.2 Power Supply Current	16
4.3 Spindle Start and Stop	16
5 Connecting Methods	18
6 SCSI Interface	20
6.1 Summary of SCSI Controller.....	20
6.2 Summary of SCSI Commands	22
7 Mounting and Handling.....	23
7.1 Orientations.....	23
7.2 Mounting of the drive.....	24
7.3 Mounting dimensions	25
7.4 Precautions on the off-line test or bench test	26
7.5 Cooling of the drive	26
7.6 Reliability temperature	26
8 Precautions for handling	27
8.1 Packing	27
8.2 Transportation.....	27
8.3 Storage	27
8.4 Other Precautions	28
9 Maintenance	28
10 Physical interface.....	29
10.1 Connector Specifications	29
10.2 Cable Specifications.....	29
10.3 Connector Layout.....	31

Drawing No.	Sheet No.	Revision	6
K6610091	6/43	2005/2/23	

11	Pin assignment	33
11.1	SCSI Bus Connector C1	33
11.2	Other connectors	37
12	Jumper Socket setting	38
12.1	Jumper connector layout.....	38
12.2	Jumper socket setting	39
12.3	Jumper socket part number	43
12.4	Extension connector (for remote cable)	43

Drawing No.	Sheet No.	Revision	6
K6610091	7/43	2005/2/23	

1 Features

The Ultrastar 10K300 series uses high performance sputtered disks, GMR heads, and a rotary type voice coil motor to drive the heads. These features provide high capacity, high speed positioning and high reliability.

The Ultrastar 10K300 series uses a SCSI interface for data transfer.

Related ANSI Specifications are as follows.

ANSI X3.301-1997	(SCSI-3 Primary Commands)
X3T10/995D Rev 11a	(SCSI-3 Primary Commands)
X3T10/996D Rev 8c	(SCSI-3 Block Commands)
X3T10/1142D Rev 20a	(SCSI Parallel Interface-2)
X3T10/1236-D Rev 20	(SCSI Primary Commands-2)
X3T10/1302D Rev 14	(SCSI Parallel Interface-3)
X3T10/1416D Rev 3	(SCSI Primary Commands-3)
X3T10/1365D Rev 4	(SCSI Parallel Interface-4)

Interface specifications for the Ultrastar 10K300 are found in the companion manual: " Hitachi 3.5 inch Magnetic Disk Drive Reference Manual for Ultrastar 10K300 (SCSI Interface Specification) ".

Table 1.1 Models

Product name	Model name	Interface type	Storage capacity (Formatted)
Ultrastar 10K300-300	HUS103030FL3600	Wide LVD (68pin-16bits) Ultra320	300GB
Ultrastar 10K300-147	HUS103014FL3600	Wide LVD (68pin-16bits) Ultra320	147GB
Ultrastar 10K300-73	HUS103073FL3600	Wide LVD (68pin-16bits) Ultra320	73GB
Ultrastar 10K300-36	HUS103036FL3600	Wide LVD (68pin-16bits) Ultra320	36GB
Ultrastar 10K300-300	HUS103030FL3800	SCA-2 LVD (80pin-16bits) Ultra320	300GB
Ultrastar 10K300-147	HUS103014FL3800	SCA-2 LVD (80pin-16bits) Ultra320	147GB
Ultrastar 10K300-73	HUS103073FL3800	SCA-2 LVD (80pin-16bits) Ultra320	73GB
Ultrastar 10K300-36	HUS103036FL3800	SCA-2 LVD (80pin-16bits) Ultra320	36GB

Note 1: This document may be changed without notice._

Drawing No.	Sheet No.	Revision	6
K6610091	8/43	2005/2/23	

2 Standards and Related Documents

(a) Safety standards

It is the user's responsibility to assure the actual system in which the drive is installed meets the appropriate safety requirements. However, the drive was tested to be in compliance with the following standards:

UL 60950 3rd Edition
CAN/ CSA-C22.2 No.60950
IEC 60950: 1991
EN60950: 1992

(b) Regulations related to electro-magnetic compatibility

It is the user's responsibility to assure the actual system in which the drive is installed meets the appropriate EMI requirements. However the drive will be tested using proper shielding and grounding to be in compliance with the following regulations:

FCC Part 15, class B
VCCI class B
EN55022 class B
CNS13438,C6357 class B (BSMI)
AS/NZS 3548 class B (C-Tick)
RRL mark for Korean EMC

(c) Related Documents

- (1) Hitachi 3.5 inch Magnetic Disk Drive Reference Manual for Ultrastar 10K300
(SCSI Interface Specification)
K6610095
- (2) Packing Specification

- (3) Ultrastar 10K300-300 (SCSI) Design Verification Test Reports
K6610096
- (4) Ultrastar 10K300-147 (SCSI) Design Verification Test Reports
K6610097
- (5) Ultrastar 10K300-73 (SCSI) Design Verification Test Reports
K6610098
- (6) Ultrastar 10K300-36 (SCSI) Design Verification Test Reports
K6610099

Drawing No.	Sheet No.	Revision	6
K6610091	9/43	2005/2/23	

3 Description

3.1 Characteristics

Table 3.1 Characteristics

Item		Specifications								unit	
		Ultrastar 10K300-300		Ultrastar 10K300-147		Ultrastar 10K300-73		Ultrastar 10K300-36			
Configuration	Storage capacity (formatted) (see Note 1,2,13)	300	147	73	36					GB	
	Bytes/sector (see Note 3)	512, 514, 516, 520, 522, 524, 528								Bytes	
	Number of disks	5	3	2	1						
	Number of heads	10	5	3	2						
	Areal density	61								Gb/inch ²	
	Recording method	MEEPRML+MNP									
Performance	Seek time read / write (see Note 5)	average	4.7 / 5.1	4.5 / 4.9	4.3 / 4.8	4.3 / 4.8				ms	
		full stroke	10 / 11								ms
		1 track	0.40 / 0.45								ms
	Average latency	2.99								ms	
	Rotational speed	10025								rpm	
	Data transfer rate (In drive)	581 – 1075								Mb/s	
	Start time (see Note 5)	25								s	
	Data transfer rate (Controller) (see Note 4)	Single-Ended	Asynchronous	5.0 max.							MB/s
			Fast-5	10.0 max.							
		Fast-10	20.0 max.								
	Ultra (Fast-20)	40.0 max.									
	LVD	Ultra2 (Fast-40)	80.0 Max.								
		Ultra160 (Fast-80)	160.0 max.								
		Ultra320 (Fast-160)	320.0 max.								
	Buffer size	8M								Bytes	
Power requirement		Typ.	3sigma	Typ.	3sigma	Typ.	3sigma	Typ.	3sigma		
	12V Spin-up, peak	-	2.45	-	2.45	-	2.28	-	2.28	A	
	12V Seek, peak	-	2.52	-	2.32	-	2.15	-	2.00	A	
	12V Idle, ave.(Note15)	0.68	0.80	0.46	0.64	0.42	0.54	0.33	0.46	A	
	5V R/W, peak	-	1.79	-	1.79	-	1.79	-	1.79	A	
	5V Read, ave.	1.55	1.64	1.55	1.64	1.55	1.64	1.55	1.64	A	
	5V Write, ave.	1.45	1.54	1.45	1.54	1.45	1.54	1.45	1.54	A	
5V Idle, ave.(Note15)	0.60	0.70	0.60	0.70	0.60	0.70	0.60	0.70	A		
Physical dimensions	length x width x height	146.0x101.6x25.4								mm	
	Weight (Approximately)	0.75	0.72	0.74	0.73					kg	
Power dissipation	+12V Idle / +5V Idle, (Average)	11.2	8.5	8.0	7.0					W	
Energy consumption rate (see Note 12)		0.038	0.062	0.110	0.195						

Note: Ultrastar 10K300-300 specification values also apply to Ultrastar 10K300-147 when logically depopulated to a 147GB capacity.

Drawing No.	Sheet No.	Revision	6
K6610091	10/43	2005/2/23	

3.2 Environmental conditions and reliability

Table 3.2 Environmental conditions and reliability

Item		Ultrastar 10K300-300	Ultrastar 10K300-147	Ultrastar 10K300-73	Ultrastar 10K300-36
Environmental conditions	Temperature	operating	5 to 55°C		
		non-operating	-40 to 70°C		
		storage/shipping	-40 to 70°C		
	Temperature gradient		20°C per hour maximum		
	Humidity	operating	5 to 90%RH		
		non-operating	5 to 90%RH		
	Wet bulb temperature		29°C maximum (non condensing)		
	Atmosphere		No corrosive gas, saline atmosphere or organic-metal compound (Example. organic silicon, organic tin)		
	Altitude	operating	-300 to 3,000 m		
		non-operating	-300 to 12,000 m		
Magnetic field		400 micro Tesla maximum			
Shock and vibration	Vibration (see Note 6)	operating	9.8 m/s ² (1.0G) maximum		
		non-operating	49 m/s ² (5.0G) maximum		
	Shock (see Note 7)	operating	147 m/s ² (15G) maximum [11ms]		
		non-operating	735 m/s ² (75G) maximum [11ms]		
			2450m/s ² (250G) maximum [2ms]		
Acoustic noise	Acoustic noise (see Note 8)		3.4 bel average		
Reliability (see Note 10)	Data Reliability (see Note 9)		Recoverable error: 10 errors in 10 ¹² bits read Non-recoverable error: 10 errors in 10 ¹⁶ bits read		
	Seek error rate (see Note 9)		10 errors in 10 ⁸ seeks		
	Life		5 years (Surface temperature of HDA is 45°C or less) Life of the drive does not change in the case that the drive is used intermittently. (See section 7.6)		
	MTBF (see Note 11)		Expected 1,200,000 hours		

Drawing No.	Sheet No.	Revision	6
K6610091	11/43	2005/2/23	

- Note 1. Storage capacity does not include spare sector and spare cylinder.
- Note 2. This is the value in the case that the drive is formatted to 512 Bytes/sector.
(1 gigabyte shows 1×10^9 bytes on this document.)
- Note 3. Ultrastar 10K300 is formatted to 512 Bytes/sector as the default.
If non-512 Bytes/sector is required, customer can change it by re-format of the drive.
- Note 4. Data transfer rate is degraded with cable or host condition or electrical noise.
- Note 5. These specifications are typical under the following conditions:
1. Voltage is 5.0V/12.0V as measured on the edge of drive connector.
 2. Surface temperature of HDA is 40°C.

If SCSI commands are issued during start-up (like TEST UNIT READY or REQUEST SENSE) in less than 10 ms intervals, then the start-up time may be extended.

- Note 6. The disk drive orientation for vibration test is shown below.

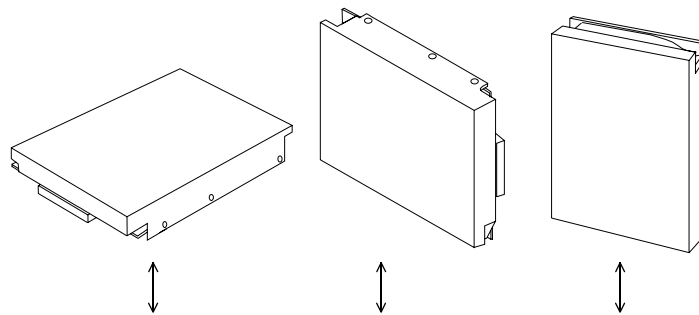

Figure 3.1 Vibration test direction

Test conditions on vibration test are as follows.

(1) Operating

- Acceleration frequency : 5 to 400 Hz,
- Acceleration level : $9.8 \text{ m/s}^2 (1.0\text{G})$
- Sweep rate : 0.5 octave / minute
- Test cycle : 1 turn

(2) Non-operating

- Acceleration frequency: 5 to 22 Hz, Maximum displacement: 2.56mm
- Acceleration frequency: 22 to 400 Hz, Acceleration level: $49 \text{ m/s}^2 (5.0\text{G})$
- Sweep rate: 0.5 octave / minute
- Test cycle: 1 turn

Drawing No.	Sheet No.	Revision	6
K6610091	12/43	2005/2/23	

Note 7. The disk drive orientation for shock test is shown in Figure 4.2.

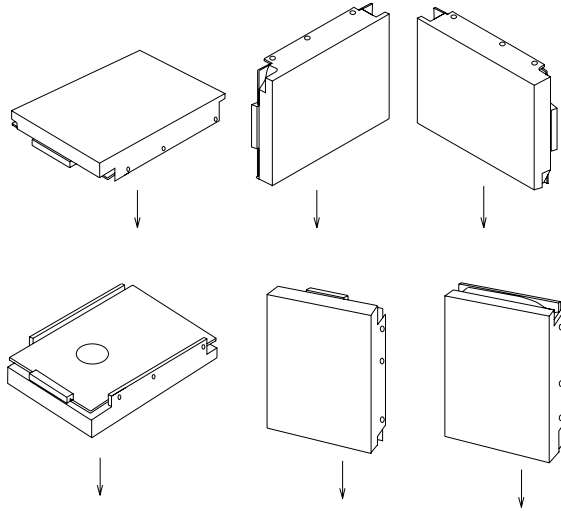

Figure 3.2 Shock test direction

Test conditions on shock test are as follows.

(1) Operating

147m/s²(15G) (Shock mode: half sine wave 11 ms, Test cycle: 5 times)

(2) Non-operating

735m/s²(75G) (Shock mode: half sine wave 11 ms, Test cycle: 5 times)

2450m/s²(250G) (Shock mode: half sine wave 2 ms, Test cycle: 5 times)

Note 8. Acoustic noise is measured except for the start, stop and seek operations.

Note 9. Recoverable error is measured at the nominal condition with voltage, temperature and default error recovery parameters.

Non-recoverable error is defined at the condition of auto-reallocation enabled.

Note 10. The drive should be mounted properly (see section 8).

Note 11. MTBF represents a prediction of performance based upon a large statistical sample calculated in accordance with Hitachi's standard procedures.

Hitachi does not warrant that the predicted MTBF is representative of any particular unit or group of units comprising a customer base. The actual failure rates will vary from unit to unit. Surface temperature of HDA is 50°C or less.

A failure defined by MTBF calculation is any event that requires repair or replacement of HDD.

Note 12. Total idle mode power (W) / Total formatted capacity (GB)

Drawing No.	Sheet No.	Revision	6
K6610091	13/43	2005/2/23	

Note 13. When the Ultrastar 10K300-300 is formatted to 512 Bytes/sector, the maximum Logical Block Address is (22ECB25B)h.

When the Ultrastar 10K300-147 is formatted to 512 Bytes/sector, the maximum Logical Block Address is (111D69B4)h.

When the Ultrastar 10K300-73 is formatted to 512 Bytes/sector, the maximum Logical Block Address is (88BB9D4)h.

When the Ultrastar 10K300-36 is formatted to 512 Bytes/sector, the maximum Logical Block Address is (445DCE9)h.

Note 14. Power measurement values in operating (Random Seek/ Read/ Write) case are shown in Table 3.3.

Table 3.3 Power measurement (Operating) Unit:(W)

	Ultrastar 10K300-300	Ultrastar 10K300-147	Ultrastar 10K300-73	Ultrastar 10K300-36
30 IOs per second	12.1	9.8	9.1	7.8
60 IOs per second	13.6	11.1	10.2	8.9
90 IOs per second	15.0	12.2	11.4	9.7

(Measurement conditions:Random Read/Write,Block Length=8,Cache=off)

Note: Ultrastar 10K300-300 specification values also apply to Ultrastar 10K300-147 when logically depopulated to a 147GB capacity.

Note 15. The rated current on the HDD label shows the current value of Idle, because the idle motion is used for the longest time. And also, Read, Write and Seek current should be considered for power supply.

Drawing No.	Sheet No.	Revision	6
K6610091	14/43	2005/2/23	

4 DC power Interface

4.1 DC Power Requirement

The drives are operated on DC power (+5V, +12V) only.

No power sequencing is required.

The +5 and +12 Volts can be applied in any order.

Table 4.1 DC Power Requirement

Power supply	Voltage tolerance	Allowed ripple and noise
+5V DC	5.0V +/-5%	Less than 150mVp-p (0 - 100kHz) Less than 100mVp-p (100kHz - 10MHz)
+12V DC	12.0V +/-5%	Less than 150mVp-p (0 - 100kHz) Less than 100mVp-p (100kHz - 10MHz)

Note 1. Voltage tolerance is measured at the DC power connector on the PCB.

The ripple current occurs during the motor start-up and seek.

Appropriate size of the DC Power cable is recommended to reduce the above ripple and noise.

Note 2. In case of fluctuations in the DC power (spikes, momentary shut off, etc.), the data being recorded or to be recorded from buffer memory are not assured.

Drawing No.	Sheet No.	Revision	6
K6610091	15/43	2005/2/23	

4.2 Power supply current

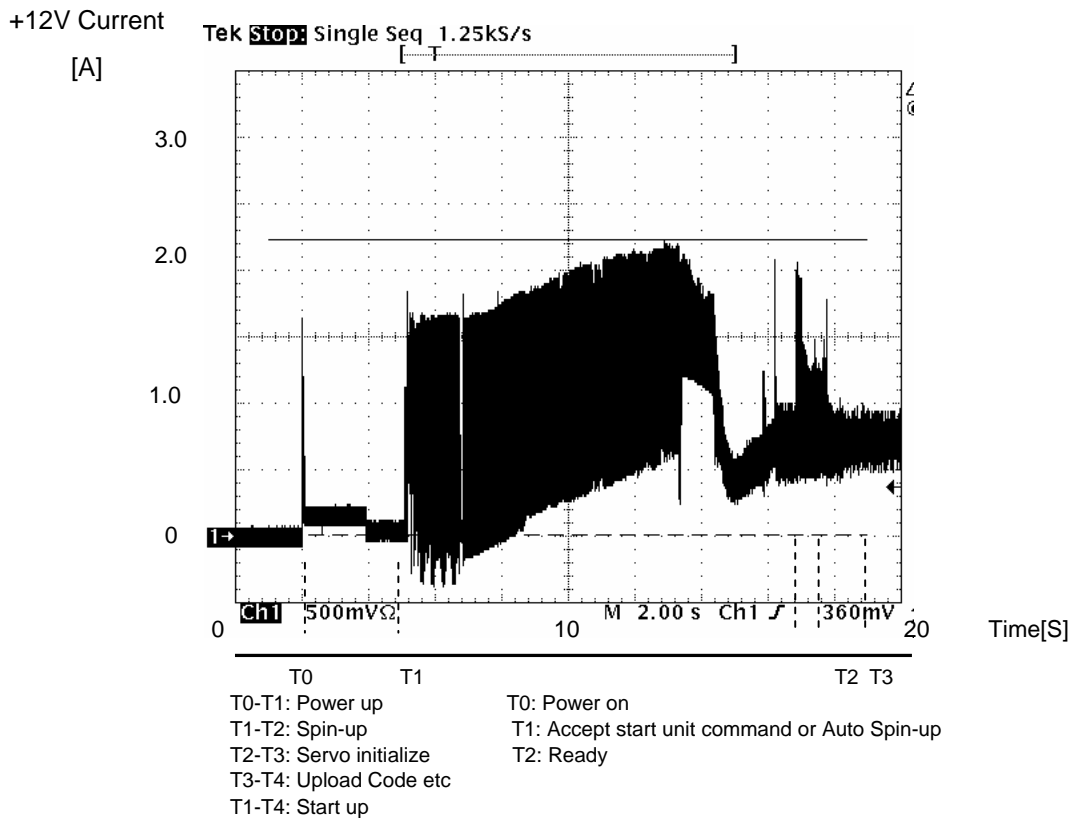

Fig 4.1 Current transition for +12V

Note: A retry Spin-up operation may be attempted during the Start up process.

4.3 Spindle Start and Stop

4.3.1 Start and Stop Time

Table 4.2 Start and Stop time

Item	Typical		unit
Start	25	Note 1	s
Stop	25	Note 2	s

Note 1. Start time means that the time of becoming ready, after DC power has been applied in the case of Enable Auto Start mode, or after Start Unit command (immed=0) has accepted in other case. If internal retry is executed during the Start-up operation, the Start time may exceed typical value. It is recommended to have 60 seconds for the Start time. In the case of a spindle start-up failure, the time of an internal retry operation is 130 seconds maximum.

Caution

Note 2. Beginning of stop time is basically decided by +12v DC power off.

In case of +5v DC power off only, stop time is 65sec(typ).

Do not move the drive until motor stop completely.

Stop time means that the time to stop the spindle rotation, after DC power has been shut off, or after stop operation has started.

Drawing No.	Sheet No.	Revision	6
K6610091	16/43	2005/2/23	

4.3.2 Spindle Start Selection

When multiple disk drives are connected to the same power supply and turned on simultaneously, a large current will be required at power up.

In the above case, it is recommended to turn the motors on one by one at intervals in order to minimize 12V line current.

This can be done according to the following 3 jumper pin configurations in the case of NW drive:

1. If Disable Auto Start mode is set (C3:9-10 installed);
 - (1) Use a spindle start command for each drive, issuing it to the next drive after receiving the previous drive's Ready condition.
 - or
 - (2) Use the spindle start command for each drive, issuing it at intervals of more than 10 seconds.

2. If Enable Auto Start mode is set (C3:9-10 removed) and Spindle Start at Power On is set (C3:13-14 removed);
Manually power on drives at intervals of more than 10 seconds.

3. If Enable Auto Start mode is set (C3:9-10 removed) and Delayed Start is set (C3:13-14 installed);
Upon power on condition, the drives will automatically spin up in 10 second intervals according to their SCSI ID. (The drive with the lowest SCSI ID will start first.)
In the case that their SCSI ID are more than 7, the drives will automatically spin up in 10 second intervals according to the numbers of (SCSI ID minus 8).

Note 1 The Delayed Start setting and the Auto Start setting can be done by commands from host via SCSI bus connector (C1) in the case of NC drive.

Drawing No.	Sheet No.	Revision	6
K6610091	17/43	2005/2/23	

5 Connecting Methods

5.1 Interface Cable (Daisy Chain)

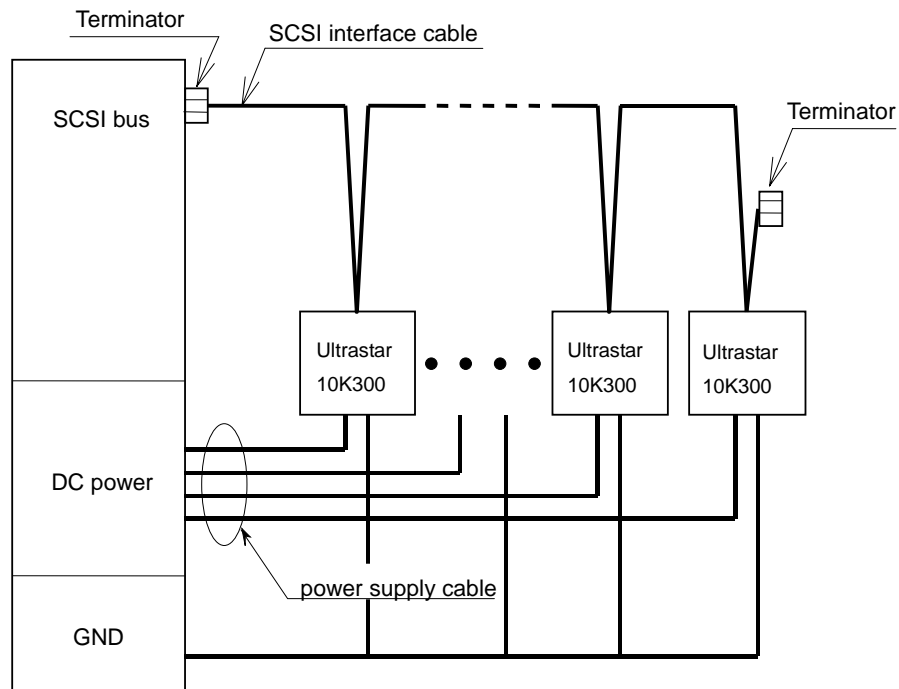

**Figure 5.1 Cabling layout
(WIDE LVD drive)**

Note 1. The SCSI bus can accommodate a maximum of 16 units on a WIDE (16-bit) bus, including the host processor, Ultrastar 10K300 units, and other SCSI devices.

Note 2. The WIDE LVD and SCA-2 LVD drives do not have the terminator on the drive, so an external terminator is required.

Drawing No.	Sheet No.	Revision	6
K6610091	18/43	2005/2/23	

5.2 Low voltage differential (LVD) mode

The NW and NC drives have two different transceivers to allow customer to use it in traditional systems which may use single-ended drivers and receivers, or to use it in low voltage differential (LVD) systems which use LVD drivers and receivers. Their I/O circuits are selectable using the I/O "DIFFSENS" line. When the I/O "DIFFSENS" line is between -0.35V and +0.5V, the drive interface circuits operate single-ended. When "DIFFSENS" is between +0.7V and +1.9V, the drive interface circuits operate LVD.

Customer can configure the drive to switch between single-ended and LVD modes using the I/O "DIFFSENS" line, or force it to operate in single-ended mode only as described later in this document.

Note 1: To operate at LVD mode, all devices on the same bus must be running in LVD mode. If you add any single-ended device to a bus that is operating in LVD mode, all devices drop back to operating in single-ended mode. This eliminates the possibility of reaching Ultra-2 SCSI transfer rates.

Note 2: Do not mix LVD drives on the same daisy chain with devices having high voltage differential (HVD) interface circuits.

Drawing No.	Sheet No.	Revision	6
K6610091	19/43	2005/2/23	

6 SCSI Interface

6.1 Summary of SCSI Controller

The Ultrastar 10K300 SCSI controller interfaces between the drive and the host computer with the Small Computer System Interface (SCSI).

(1) ANSI standard

The controller supports the SCSI interface that conforms to the ANSI specifications shown in section 2.

(2) Compact design

The controller is embedded within the disk drive.

(3) Fast data transfer rate

The controller can transfer data via asynchronous mode, Fast-5 synchronous mode, Fast-10 synchronous mode and Ultra (Fast-20) synchronous mode.

The controller can transfer data via Ultra2 (Fast-40) synchronous mode and Ultra160 (Fast-80) synchronous mode and Ultra320 (Fast-160) synchronous mode, as well as above-mentioned transfer mode.

(4) FIFO buffer

The Ultrastar 10K300 SCSI controller has 8M bytes of FIFO buffer. This data buffering feature prevents the SCSI controller from delay during the reconnect process and reduces the latency time that is generated by the difference of the data transfer rate between media and host.

(5) Automatic error retry

The controller automatically retries whenever the disk drive encounters errors.

(6) Automatic error corrections

The controller uses On-The-Fly ECC to automatically correct read errors, without latent rotational time.

(7) Parameter save feature

The controller saves the controller/device parameters (MODE SELECT parameters) specified by the host onto the disk drive. The parameters are automatically restored at power-on time.

Drawing No.	Sheet No.	Revision	6
K6610091	20/43	2005/2/23	

(8) Tagged Command Queuing

A maximum of 128 commands can be enqueued to this drive. The drive does not have to connect and disconnect to the host controller even if the SCSI command has been issued successively, so the overhead time of the SCSI bus can be reduced.

(9) S.M.A.R.T. (Self - Monitoring, Analysis and Reporting Technology)

This function helps predict a failure related to the degradation of the disk drive itself. For users seeking to use the drive as long as possible, S.M.A.R.T. can be used to predict when failure might occur. The user can use this information to back-up the data before failure.

The S.M.A.R.T. report is written on the disk at regular intervals that are not based on drive usage.

(10) Automatic Read Reallocation

When an error is detected on reading the data, this function automatically assigns an alternate sector in place of the defective sector and stores the data on the alternated sector.

(11) Write Cache

The controller can return a completion of a WRITE command with a GOOD status after receiving the data from the host but before writing the data from its buffer to the media.

The Deferred Error function reports an Disk Access Error to the host computer if an error occurs when the data are being stored on the disk medium after the GOOD status was already returned. In this case, any data still in the buffer (not yet written to the media) is not assured.

(12) Log Save

Diagnostic information is written on the disk at regular intervals that are not based on drive usage.

Drawing No.	Sheet No.	Revision	6
K6610091	21/43	2005/2/23	

6.2 Summary of SCSI Commands

The SCSI controller supports the group 0,1, and 2 commands listed in Table 6.1

Table 6.1 SCSI Commands Supported

Operation Code	Group 0 Command Name
00h	TEST UNIT READY
01h	REZERO UNIT
03h	REQUEST SENSE
04h	FORMAT UNIT
07h	REASSIGN BLOCKS
08h	READ
0Ah	WRITE
0Bh	SEEK
12h	INQUIRY
15h	MODE SELECT
16h	RESERVE
17h	RELEASE
1Ah	MODE SENSE
1Bh	START/STOP UNIT
1Ch	RECEIVE DIAGNOSTIC RESULTS
1Dh	SEND DIAGNOSTIC
Operation Code	Group 1 Command Name
25h	READ CAPACITY
28h	READ (EXTENDED)
2Ah	WRITE (EXTENDED)
2Bh	SEEK (EXTENDED)
2Eh	WRITE AND VERIFY
2Fh	VERIFY
35h	SYNCHRONIZED CACHE
37h	READ DEFECT DATA
3Bh	WRITE BUFFER
3Ch	READ BUFFER
3Eh	READ LONG
3Fh	WRITE LONG

Drawing No.	Sheet No.	Revision	6
K6610091	22/43	2005/2/23	

Table 6.1 SCSI Commands Supported (Continued)

Operation Code	Group 2 Command Name
41h	WRITE SAME
4Ch	LOG SELECT
4Dh	LOG SENSE
55h	MODE SELECT (10)
56h	RESERVE (10)
57h	RELEASE (10)
5Ah	MODE SENSE (10)
5Eh	PERSISTENT RESERVE IN
5Fh	PERSISTENT RESERVE OUT
Operation Code	Group 5 Command Name
B7h	READ DEFECT DATA (12)
A0h	REPORT LUNS

7 Mounting and Handling

7.1 Orientations

The following orientations are acceptable.

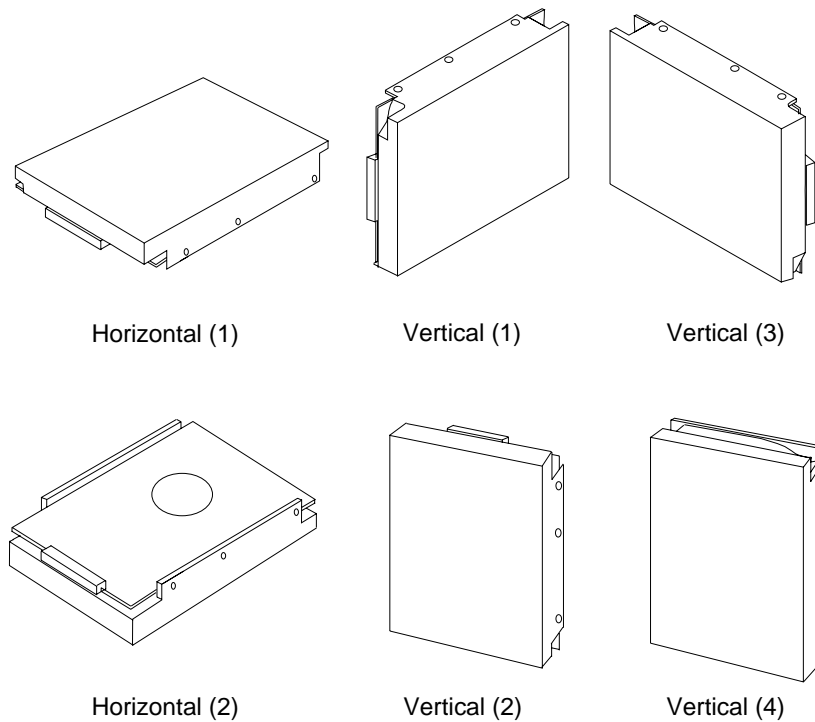

Fig. 7.1 Orientations

Drawing No.	Sheet No.	Revision	6
K6610091	23/43	2005/2/23	

Caution

7.2 Mounting of the drive

1. Mount the drive with four 6-32 UNC screws. (Screw's torque : 0.588 to 0.784 N·m)

2. Mounting holes (A1,A2,B1,B2,B3) are available for mounting.(See figure 8.3)

It is recommended that the 4 holes, (A1,A2 or B1,B3 on figure 8.3), be used for mounting to keep the proper space between mounting holes.

3. Maximum penetration of the screw is 3.8 mm.

4. Keep a clearance of 3 millimeters from the PCB parts side and the HDA's upper surface for proper cooling air ventilation. (See figure 8.2)

5. The mounting chassis's weight shall be more than 2 kg, and the stiffness of mounting chassis shall be more than 196,000 N/m. The stiffness of 4 mounting points shall not be unbalanced.

6. The HDA enclosure is connected to the DC ground on PCB in HDA electrically.

If electrical insulation of the HDA is preferred when it is mounted to the mounting chassis, insert an insulator between the HDA enclosure and the mounting chassis.

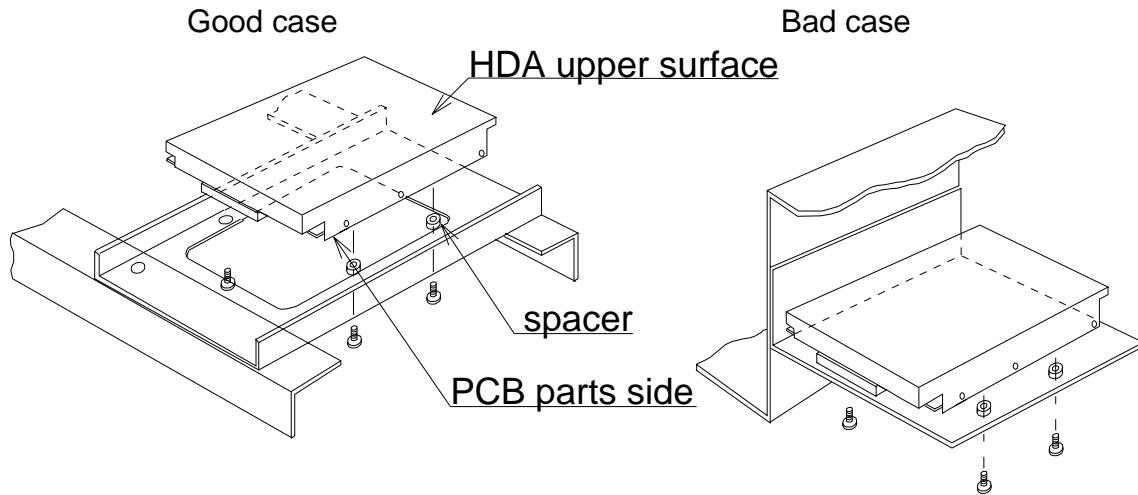
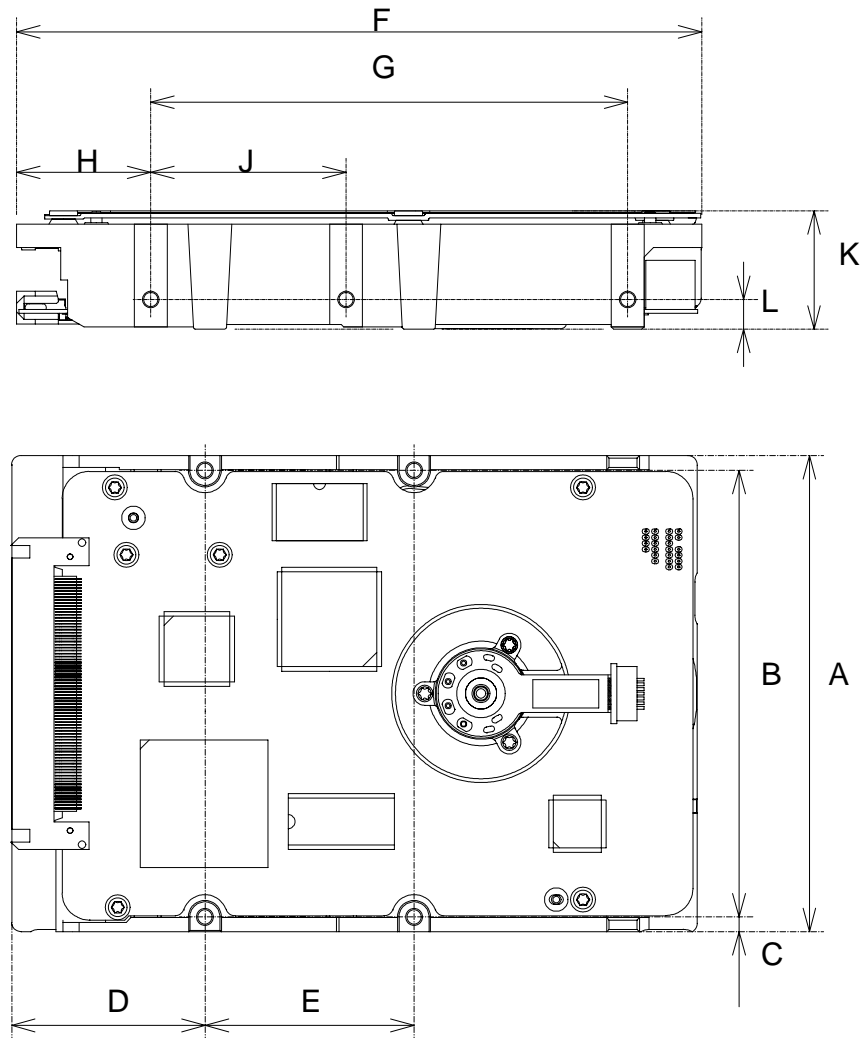

Figure 7.2 Example for mounting

Drawing No.	Sheet No.	Revision	6
K6610091	24/43	2005/2/23	

7.3 Mounting dimensions



Dimension	mm
A	101.6±0.25
B	95.25±0.25
C	3.18±0.25
D	41.28±0.5
E	44.45±0.25
F	147 max.
G	101.6±0.25
H	28.5±0.5
J	41.6±0.25
K	26.1 max.
L	6.35±0.25

Figure 7.3 Layout of Mounting holes

Drawing No.	Sheet No.	Revision	6
K6610091	25/43	2005/2/23	

7.4 Precautions on the off-line test or bench test

When the off-line test or bench test is performed the drive should be tightly fixed and cooled. The set-up should be similar to the actual system configuration.

7.5 Cooling of the drive

Keep the drive (HDA and PCB) cool by using a FAN. Reliability and life of the drive increases as the temperature is lower.

Caution

7.6 Reliability temperature

The temperature measurement points and temperature limits are shown below.

1. The maximum temperature assures the data reliability, seek error rate, and must not be exceeded.
2. The reliability temperature maintains the MTBF of the drive and must not be exceeded in order to ensure its reliability. MTBF is also based on a nominal voltage condition.
3. The maximum temperature of HDA includes momentary temperature rise. Average temperature of HDA has to be less than this temperature.

Table 7.1 Temperature Limits (unit: °C)

Measurement points	HDA(top)	HDA(bottom)	IC(RW)	IC(MPU)
Maximum temperature	65	65	85	85
Reliability temperature	50	50	70	70

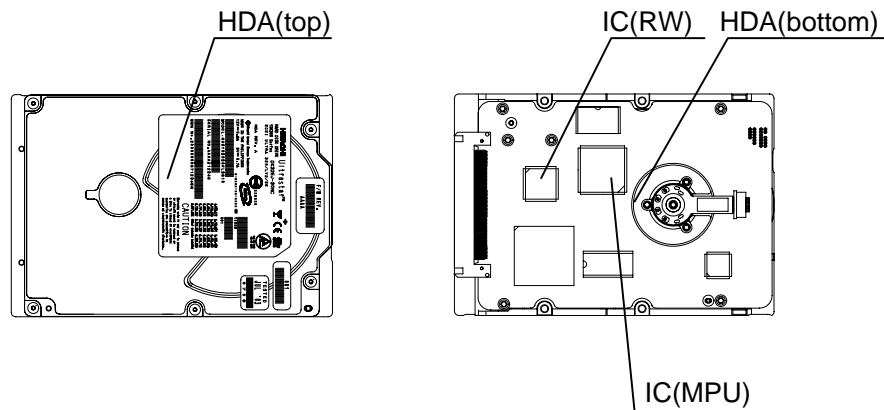

Figure 7.4 Temperature Measurement Points

Drawing No.	Sheet No.	Revision	6
K6610091	26/43	2005/2/23	

Caution

8 Precautions for handling

The drive is sensitive to shock, vibration, over voltage, temperature, humidity, corrosive gas, magnetic force and electrostatic discharge.

If these forces contact the electrical or mechanical components (magnetic heads, magnetic disks), the drive will break down, degrade, or storage data will be lost.

The following handling guidelines are mandatory.

- (1) Handle the drive on the appropriate cushion (for example, anti-static pad with thickness of 10mm or more) to prevent from shock and vibration.
- (2) Handle the drive with a wrist band, an anti-static mat, or without direct touch of the hands to the PCB in order to prevent static electricity discharge.
- (3) Handle the drive in an environment (Temperature, Moisture, Corrosive gas), which follows the drive specification and prevents unforeseen complications.

8.1 Packing

After cleaning the drive, pack it in the following manner to protect it from moisture.

- (1) Put the drive in an electro-static shielding bag with desiccant.
- (2) Packing materials, i.e. electro-static shielding bag, cardboard box, cushion, etc., should not contain corrosive gas, saline or organic-metal compound. (Example organic silicon, organic tin)
- (3) If the package has no damage after unpacking, reserve it for storage or Transportation of the drive.

But 20-unit packing material is suitable for only 20 units packing.

When less than 19 units, it is recommended to use the 5-unit packing material.

5-units packing material covers the quantity from 1 to 5.

8.2 Transportation

- (1) Pack the drive so as to maintain above-mentioned environmental conditions during transportation. (Refer to section 4.2)
- (2) When you take the drive out of the packing case and carry it on a hand truck, lay it on cushioning material (for example, urethane foam cushioning with a thickness of 10mm or more).

8.3 Storage

When storing, pack the drive to protect it against moisture. (Refer to section 4.2)

In case that storage period becomes long, exchange a desiccant and repack.

This operation shall be executed every 3 months. (Recommendation)

Drawing No.	Sheet No.	Revision	6
K6610091	27/43	2005/2/23	

8.4 Other Precautions

- 8.4.1 Do not loosen the screws or disassemble the drive.
- 8.4.2 Do not remove the PCB from the drive or swap the PCB with other drives.
- 8.4.3 Do not solder the wire or other parts on the PCB, or reconstruct the PCB.
- 8.4.4 Do not remove the sealing tape or label on the HDA.
- 8.4.5 Turn off the power before removing or installing the DC power cable and SCSI interface cable. Turn off the power before removing or installing the jumper.
- 8.4.6 Remove the DC power and SCSI interface connectors carefully in order not to damage the contact pins and the connector housing.
- 8.4.7 Do not move the drive when the disks are rotating or while the power is on or for 20 seconds after the power has been turned off.

9 Maintenance

- 9.1 The HDD itself is maintenance free and there are no individual parts that require maintenance. If maintenance for the HDD is required, the entire product will need to be serviced, since it can not be divided into parts. System maintenance should be executed by the host system.
- 9.2 The supplier will repair or exchange the product due to malfunction covered under the warranty. The warranty and service will be agreed upon between the customer and the supplier. The supplier is neither liable or obligated to service any product due to carelessness or mishandling of product.
- 9.3 Even if the drive fault occurs during the In-warranty period, the supplier will repair or replace the drive but will not be liable for any expenses of disk drive installation or detachment to or from system. (This includes data back up, data copy, etc.)

Drawing No.	Sheet No.	Revision	6
K6610091	28/43	2005/2/23	

10 Physical interface

10.1 Connector Specifications

Use the mating connectors which are electrically and mechanically compatible.
The following part numbers indicate the mating connectors.

Table 10.1 Interface connectors

Interface	Name	Part number	Manufacturer
WIDE LVD	SCSI interface connector	786090-7 DHJ-PAC68-2AN	AMP DDK
	DC power connector	Pin:61314-4 Housing:1-480424-0	AMP AMP
SCA-2 LVD	SCSI interface connector with DC power connector	787311-1	AMP
		787565-1	AMP
		HD2-PA080-S11	DDK

10.2 Cable Specifications

(1) SCSI Interface Cable

Use interface cables that meet the ANSI SCSI guideline.

The total cable length must be within the maximum cable length in case multiple drives are daisy chained. Specifications of maximum cable length are shown in Table 10.2 and Table 10.3.

The length of a cable connected between SCSI devices must be a minimum of 12 cm. (The stub length of the drive: 4 cm)

If an external cable the stub length of which becomes long is connected to the devices, the cable length between the devices must be a minimum of (external stub length + 4 cm) x 3.

If data are transferred by Ultra SCSI (Fast-20) mode, Ultra2 SCSI (Fast-40) mode, Ultra160 SCSI (Fast-80) mode or Ultra320 SCSI (Fast-160) mode, check that the interface reflection noise does not influence the motion of the drive in the actual user's system.

Drawing No.	Sheet No.	Revision	6
K6610091	29/43	2005/2/23	

(2) DC Power Supply Cable

The DC power cable should be as short as possible to minimize voltage drop.

Table 10.2 Interface cable (WIDE, Single-ended mode)

	Cable Type	Maximum cable length		
		Fast-5	Fast-10	Ultra (Fast 20)
SCSI interface	Flat Ribbon or Twisted Pair	6m (16 units max.)	3m (16 units max.)	3m (4 units max.) or 1.5m (8 units max.)
DC power supply	AWG#20	3m		

Table 10.3 Interface cable (WIDE, LVD mode)

	Cable Type	Maximum cable length
		Ultra2 (Fast-40), Ultra160 (Fast-80) , Ultra320 (Fast-160)
SCSI interface	Flat Ribbon or Twisted Pair	12m (16 units max.)
DC power supply	AWG#20	3m

Shield the cables as necessary to improve the interface noise immunity, especially if the cables run close to noise generating devices or exit the frame or chassis.

Drawing No.	Sheet No.	Revision	6
K6610091	30/43	2005/2/23	

10.3 Connector Layout
WIDE LVD drive

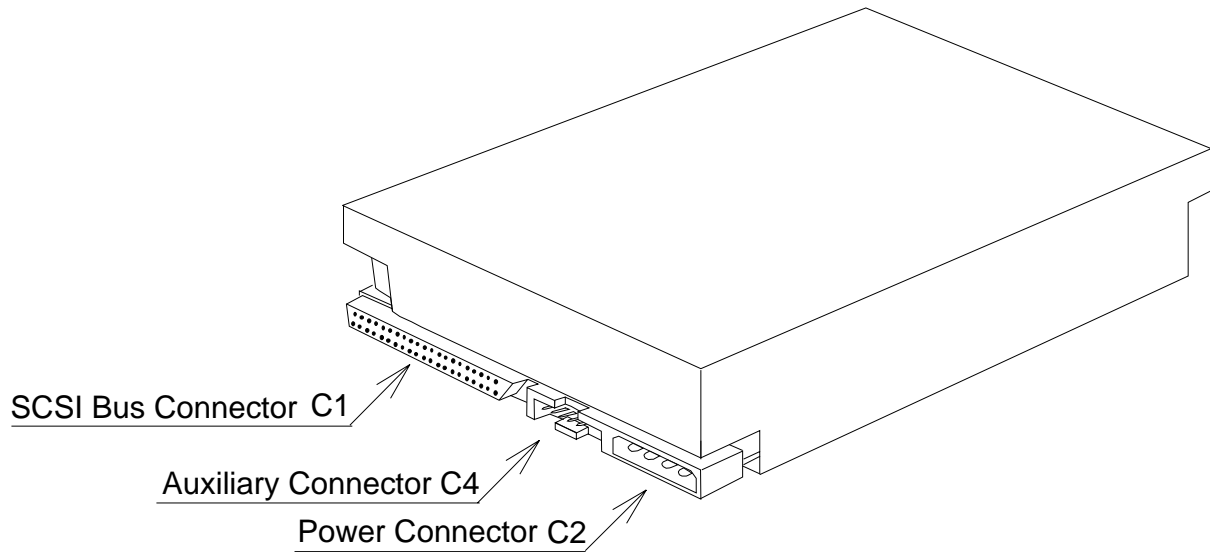

Figure 10.1 Connector Layout (WIDE LVD drive)

C2-1 : 12V
C2-2 : GND (12V Return)
C2-3 : GND (5V Return)
C2-4 : 5V

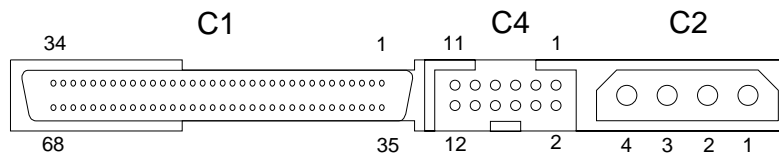
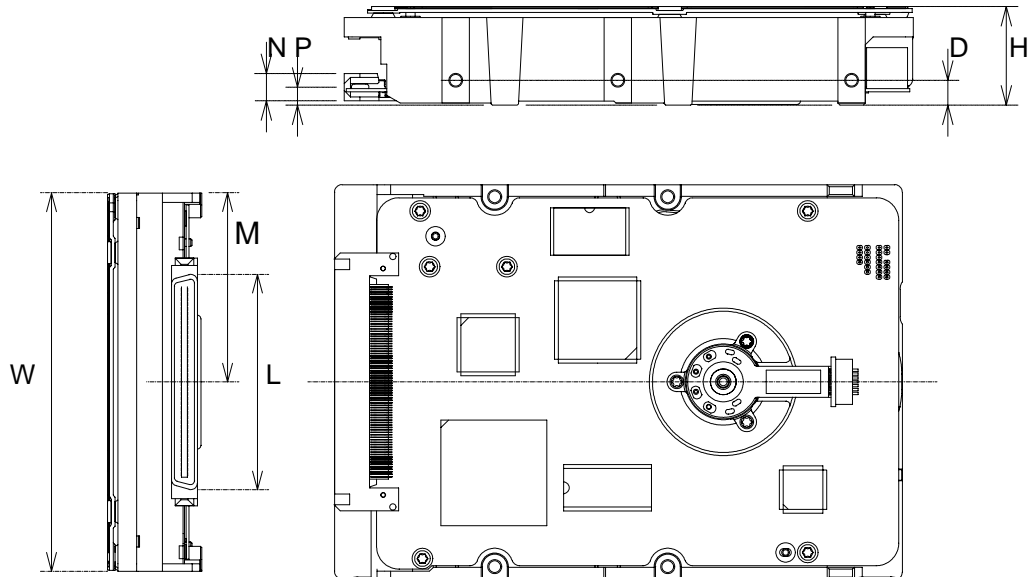

Figure 10.2 Connector view

Note: The SCSI ID setting is to be set via the C3 connector (not by C4) normally.
In case the SCSI ID setting is done by remote switch via the C4 connector and remote cable, remove all Jumper Sockets from the C3 connector to avoid SCSI ID control conflicts.

Drawing No.	Sheet No.	Revision	6
K6610091	31/43	2005/2/23	

SCA-2 LVD drive



Dimension	mm	Dimension	mm
H	26.1 max.	W	101.6±0.25
D	6.35±0.25	L	(58)
N	(7)	M	50.8±0.5
P	4.6±0.5		

Figure 10.3 Connector Layout (SCA-2 LVD drive)

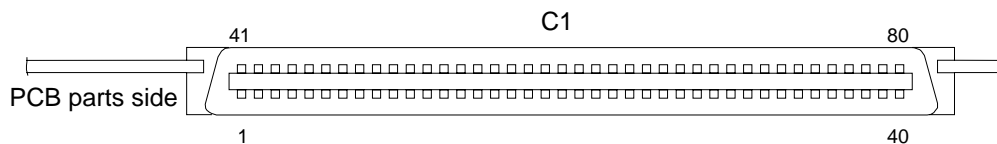

Figure 10.4 Connector view

Drawing No.	Sheet No.	Revision	6
K6610091	32/43	2005/2/23	

11 Pin assignment

11.1 SCSI Bus Connector C1

**Table 11.1 Pin assignment of SCSI Bus Connector C1
(WIDE, Single-ended mode)**

Signal Name	Connector contact No.	Cable conductor No.		Connector contact No.	Signal Name
GND	1	1	2	35	-DB(12)
GND	2	3	4	36	-DB(13)
GND	3	5	6	37	-DB(14)
GND	4	7	8	38	-DB(15)
GND	5	9	10	39	-DB(P1)
GND	6	11	12	40	-DB(0)
GND	7	13	14	41	-DB(1)
GND	8	15	16	42	-DB(2)
GND	9	17	18	43	-DB(3)
GND	10	19	20	44	-DB(4)
GND	11	21	22	45	-DB(5)
GND	12	23	24	46	-DB(6)
GND	13	25	26	47	-DB(7)
GND	14	27	28	48	-DB(P0)
GND	15	29	30	49	GND
DIFFSENS	16	31	32	50	GND
TERMPWR	17	33	34	51	TERMPWR
TERMPWR	18	35	36	52	TERMPWR
Reserved	19	37	38	53	Reserved
GND	20	39	40	54	GND
GND	21	41	42	55	-ATN
GND	22	43	44	56	GND
GND	23	45	46	57	-BSY
GND	24	47	48	58	-ACK
GND	25	49	50	59	-RST
GND	26	51	52	60	-MSG
GND	27	53	54	61	-SEL
GND	28	55	56	62	-C/D
GND	29	57	58	63	-REQ
GND	30	59	60	64	-I/O
GND	31	61	62	65	-DB(8)
GND	32	63	64	66	-DB(9)
GND	33	65	66	67	-DB(10)
GND	34	67	68	68	-DB(11)

Drawing No.	Sheet No.	Revision	6
K6610091	33/43	2005/2/23	

Table 11.2 Pin assignment of SCSI Bus Connector C1 (WIDE, LVD mode)

Signal Name	Connector contact No.	Cable conductor No.		Connector contact No.	Signal Name
+DB(12)	1	1	2	35	-DB(12)
+DB(13)	2	3	4	36	-DB(13)
+DB(14)	3	5	6	37	-DB(14)
+DB(15)	4	7	8	38	-DB(15)
+DB(P1)	5	9	10	39	-DB(P1)
+DB(0)	6	11	12	40	-DB(0)
+DB(1)	7	13	14	41	-DB(1)
+DB(2)	8	15	16	42	-DB(2)
+DB(3)	9	17	18	43	-DB(3)
+DB(4)	10	19	20	44	-DB(4)
+DB(5)	11	21	22	45	-DB(5)
+DB(6)	12	23	24	46	-DB(6)
+DB(7)	13	25	26	47	-DB(7)
+DB(P0)	14	27	28	48	-DB(P0)
GND	15	29	30	49	GND
DIFFSENS	16	31	32	50	GND
TERMPWR	17	33	34	51	TERMPWR
TERMPWR	18	35	36	52	TERMPWR
Reserved	19	37	38	53	Reserved
GND	20	39	40	54	GND
+ATN	21	41	42	55	-ATN
GND	22	43	44	56	GND
+BSY	23	45	46	57	-BSY
+ACK	24	47	48	58	-ACK
+RST	25	49	50	59	-RST
+MSG	26	51	52	60	-MSG
+SEL	27	53	54	61	-SEL
+C/D	28	55	56	62	-C/D
+REQ	29	57	58	63	-REQ
+I/O	30	59	60	64	-I/O
+DB(8)	31	61	62	65	-DB(8)
+DB(9)	32	63	64	66	-DB(9)
+DB(10)	33	65	66	67	-DB(10)
+DB(11)	34	67	68	68	-DB(11)

Drawing No.	Sheet No.	Revision	6
K6610091	34/43	2005/2/23	

**Table 11.3 Pin assignment of SCSI Bus Connector C1
(SCA-2, Single-ended mode)**

Signal Name	Connector contact No.		Signal Name
12V	1	41	GND(12V Return)
12V	2	42	GND(12V Return)
12V	3	43	GND(12V Return)
12V	4	44	MATED1 (Note 2)
Open	5	45	Open
Open	6	46	DIFFSENS
-DB(11)	7	47	GND
-DB(10)	8	48	GND
-DB(9)	9	49	GND
-DB(8)	10	50	GND
-I/O	11	51	GND
-REQ	12	52	GND
-C/D	13	53	GND
-SEL	14	54	GND
-MSG	15	55	GND
-RST	16	56	GND
-ACK	17	57	GND
-BSY	18	58	GND
-ATN	19	59	GND
-DB(P0)	20	60	GND
-DB(7)	21	61	GND
-DB(6)	22	62	GND
-DB(5)	23	63	GND
-DB(4)	24	64	GND
-DB(3)	25	65	GND
-DB(2)	26	66	GND
-DB(1)	27	67	GND
-DB(0)	28	68	GND
-DB(P1)	29	69	GND
-DB(15)	30	70	GND
-DB(14)	31	71	GND
-DB(13)	32	72	GND
-DB(12)	33	73	GND
5V	34	74	MATED2 (Note 2)
5V	35	75	GND(5V Return)
5V	36	76	GND(5V Return)
Reserved	37	77	LED(with 0 ohm)
AUTO START (Note 1)	38	78	-DELAY START (Note 1)
-ID0 (Note 1)	39	79	-ID1 (Note 1)
-ID2 (Note 1)	40	80	-ID3 (Note 1)

Note 1 When this signal is held to ground, it is regarded as LOW. When this signal is open, it is regarded as HIGH. It can be driven by open collector driver.

Do not pull up this signal.

Note 2 The MATED2 signal is tied to ground, and the MATED1 signal is pulled up to HIGH level in the drive. When the drive detects the MATED1 signal is held to LOW, the drive regards the connection has completed. When the drive detects the MATED1 signal is held to HIGH, it regards the connection is incomplete.

Drawing No.	Sheet No.	Revision	6
K6610091	35/43	2005/2/23	

Table 11.4 Pin assignment of SCSI Bus Connector C1 (SCA-2, LVD mode)

Signal Name	Connector contact No.		Signal Name
12V	1	41	GND(12V Return)
12V	2	42	GND(12V Return)
12V	3	43	GND(12V Return)
12V	4	44	MATED1 (Note 2)
Open	5	45	Open
Open	6	46	DIFFSENS
-DB(11)	7	47	+DB(11)
-DB(10)	8	48	+DB(10)
-DB(9)	9	49	+DB(9)
-DB(8)	10	50	+DB(8)
-I/O	11	51	+I/O
-REQ	12	52	+REQ
-C/D	13	53	+C/D
-SEL	14	54	+SEL
-MSG	15	55	+MSG
-RST	16	56	+RST
-ACK	17	57	+ACK
-BSY	18	58	+BSY
-ATN	19	59	+ATN
-DB(P0)	20	60	+DB(P0)
-DB(7)	21	61	+DB(7)
-DB(6)	22	62	+DB(6)
-DB(5)	23	63	+DB(5)
-DB(4)	24	64	+DB(4)
-DB(3)	25	65	+DB(3)
-DB(2)	26	66	+DB(2)
-DB(1)	27	67	+DB(1)
-DB(0)	28	68	+DB(0)
-DB(P1)	29	69	+DB(P1)
-DB(15)	30	70	+DB(15)
-DB(14)	31	71	+DB(14)
-DB(13)	32	72	+DB(13)
-DB(12)	33	73	+DB(12)
5V	34	74	MATED2 (Note 2)
5V	35	75	GND(5V Return)
5V	36	76	GND(5V Return)
Reserved	37	77	LED(with 0 ohm)
AUTO START (Note 1)	38	78	-DELAY START (Note 1)
-ID0 (Note 1)	39	79	-ID1 (Note 1)
-ID2 (Note 1)	40	80	-ID3 (Note 1)

Note 1 When this signal is held to ground, it is regarded as LOW. When this signal is open, it is regarded as HIGH. It can be driven by open collector driver.

Do not pull up this signal.

Note 2 The MATED2 signal is tied to ground, and the MATED1 signal is pulled up to HIGH level in the drive. When the drive detects the MATED1 signal is held to LOW, the drive regards the connection has completed. When the drive detects the MATED1 signal is held to HIGH, it regards the connection is incomplete.

Drawing No.	Sheet No.	Revision	6
K6610091	36/43	2005/2/23	

11.2 Other connectors

Table 11.5 Pin assignment of Auxiliary Connector C4 (WIDE LVD drive)

Pin No.	Signal Name	Pin No.	Signal Name	Note
1	-ID0	2	Reserved	
3	-ID1	4	Reserved	
5	-ID2	6	Reserved	
7	-ID3	8	LED(with 150 ohm)	See Figure 12.1
9	N.C.	10	GND	
11	5V	12	-WRITE PROTECT	

Table 11.6 Pin assignment of Option Jumper Connector C3 (WIDE LVD drive)

Pin No.	Signal Name	Pin No.	Signal Name	Note
1	-ID3	2	GND	
3	-ID2	4	GND	
5	-ID1	6	GND	
7	-ID0	8	GND	
9	-Disable Auto Start	10	GND	
11	-Force Single-Ended mode	12	GND	
13	-Enable Delayed Start	14	GND	
15	-Write Protect	16	GND	
17	Reserved	18	GND	
19	Reserved	20	GND	
21	LED(with 0 ohm)	22	5V(with 150 ohm)	See Figure 12.1
23	Term. Power to SCSI bus	24	Term. Power to SCSI bus	

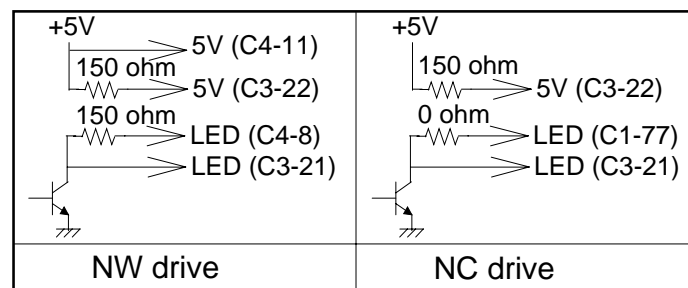

Figure 11.1 LED Driver

Drawing No.	Sheet No.	Revision	6
K6610091	37/43	2005/2/23	

12 Jumper Socket setting

12.1 Jumper connector layout

WIDE LVD drive

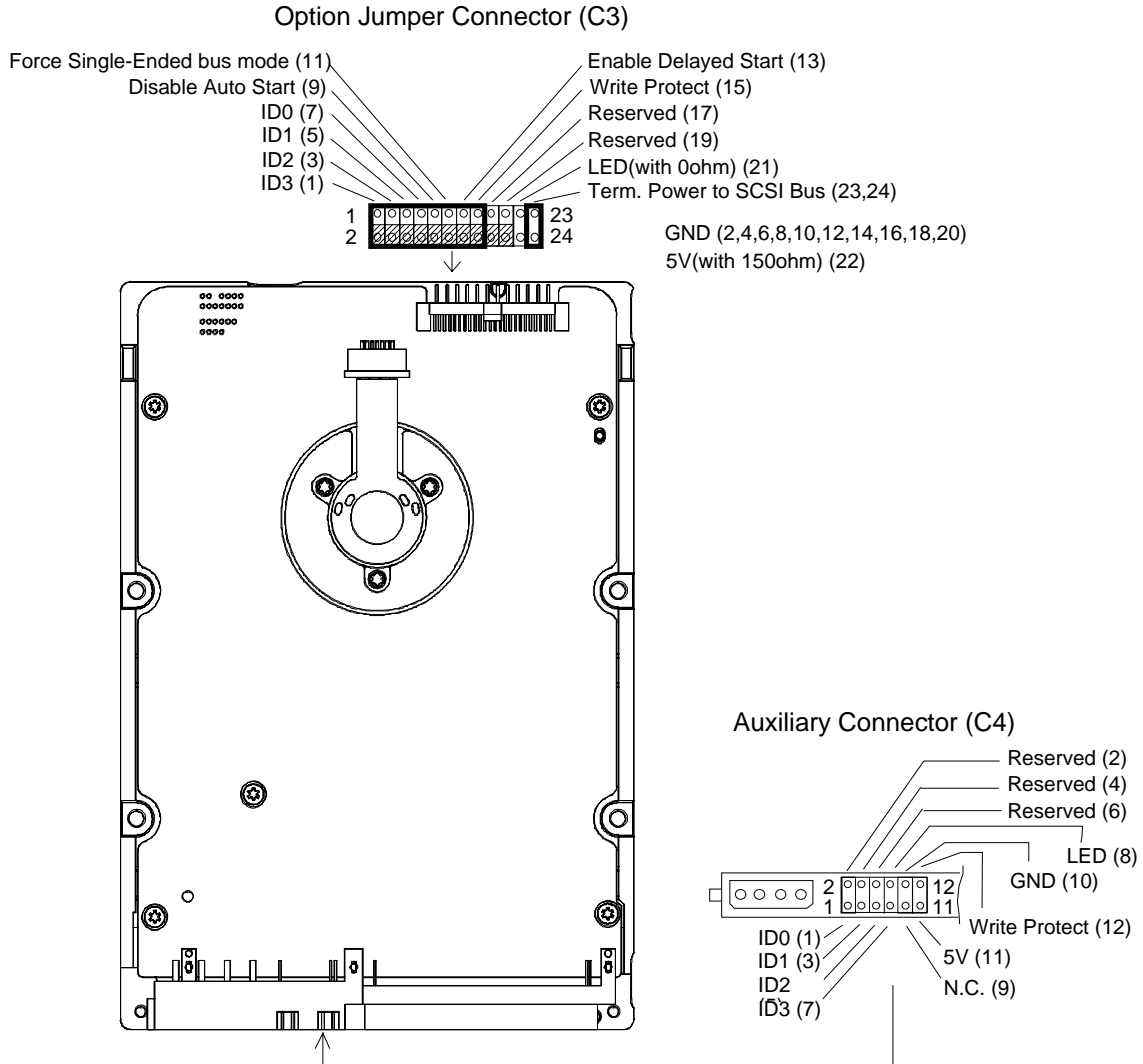

Figure 12.1 Jumper connector layout (WIDE LVD drive)

Note 1. Green or White jumper sockets are used for the customer's selection. (They are shown with thick lines in figure 13.1)

2. Shaded jumper sockets are default setting at the factory.
3. Reserved pins (C3-17,19; C4-2,4,6) are used at the factory. Installing or removing jumper sockets on these reserved pins will void any warranties of the HDD.

Do not connect an assigned pin to another assigned pin.

4. Jumpers are installed at C3-2,4 & 6,8 & 10,12 & 14,16 & 18,20 as spares. Customer can remove and use them for another jumper settings.



Drawing No.	Sheet No.	Revision	6
K6610091	38/43	2005/2/23	

12.2 Jumper socket setting

The Jumper sockets should be set only when the power is off.

12.2.1 SCSI ID

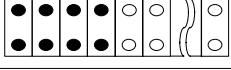
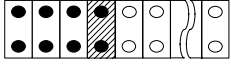
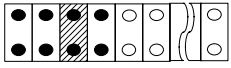
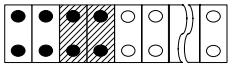
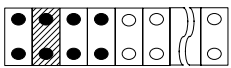
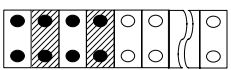
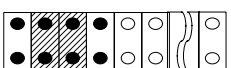
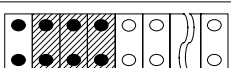
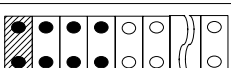
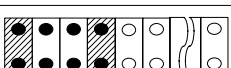
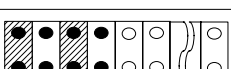
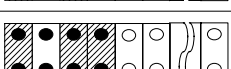
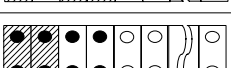
WIDE LVD

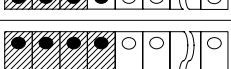
No.	Option Jumper Connector (C3)	SCSI ID #
0	 Remove all Jumper Sockets (Default)	0
1	 Install the Jumper Socket for C3-7,8	1
2	 Install the Jumper Socket for C3-5,6	2
3	 Install the Jumper Sockets for C3-5,6 & 7,8	3
4	 Install the Jumper Socket for C3-3,4	4
5	 Install the Jumper Sockets for C3-3,4 & 7,8	5
6	 Install the Jumper Sockets for C3-3,4 & 5,6	6
7	 Install the Jumper Sockets for C3-3,4 & 5,6 & 7,8	7
8	 Install the Jumper Socket for C3-1,2	8
9	 Install the Jumper Sockets for C3-1,2 & 7,8	9
10	 Install the Jumper Sockets for C3-1,2 & 5,6	10
11	 Install the Jumper Sockets for C3-1,2 & 5,6 & 7,8	11
12	 Install the Jumper Sockets for C3-1,2 & 3,4	12
13	 Install the Jumper Sockets for C3-1,2 & 3,4 & 7,8	13
14	 Install the Jumper Sockets for C3-1,2 & 3,4 & 5,6	14
15	 Install the Jumper Sockets for C3-1,2 & 3,4 & 5,6 & 7,8	15

Note.1 Jumpers are installed at C3-2,4 & 6,8 & 10,12 & 14,16 & 18,20 as spares.

Customer can remove and use them for another jumper settings.

Drawing No.	Sheet No.	Revision	6
K6610091	39/43	2005/2/23	

12.2.4 Enable Delayed Start

WIDE LVD

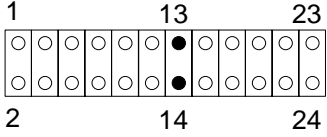
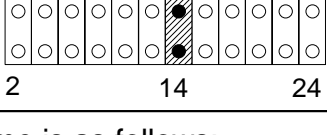
No.	Option Jumper Connector (C3)	Meaning
1	<p>Remove the Jumper Socket for C3-13,14 (Default)</p>  <p>1 13 23 ○ ○ ○ ○ ○ ○ ● ○ ○ ○ ○ ○ ○ ○ ○ ○ ○ ○ ● ○ ○ ○ ○ ○ 2 14 24</p>	Spindle motor automatically starts when the power is on.
2	<p>Install the Jumper Socket for C3-13,14</p>  <p>1 13 23 ○ ○ ○ ○ ○ ○ ▨ ○ ○ ○ ○ ○ ○ ○ ○ ○ ○ ○ ○ ● ○ ○ ○ ○ ○ 2 14 24</p>	Spindle motor starts in sequence via ID number x 10 seconds from the time power is applied (NOTE 1)

Note 1. This time is as follows:

ID number 0 to 7 : ID number x 10sec

ID number 8 to 15 : (ID number - 8) x 10sec

Note 2. This jumper is valid only when Auto Start setting is done.

Note 3. If setting for Delayed Start is done by host via SCSI bus connector (C1) in SCA-2 LVD drive, remove jumper in C3-13,14.

Note 4. If DELAY START in SCSI bus connector (C1) in SCA-2 LVD drive is grounded by host, jumper setting in C3-13,14 is invalid.

Drawing No.	Sheet No.	Revision	6
K6610091	41/43	2005/2/23	

12.3 Jumper socket part number

Part numbers of jumper sockets are as follows:

Table 12.1 Jumper socket

Connector	Name	Part number	Manufacturer
Option Jumper Connector (C3)	MINITEK JUMPER	86730-001	FCI Japan K.K.

12.4 Extension connector

Part numbers of extension connectors for remote cable are as follows:

Table 12.2 Extension connector

Connector	Name	Part number	Manufacturer
Auxiliary Connector (C5) (NW drive)	Microbit housing	FCN-723J012/2M	FUJITSU LIMITED
	Microbit contact	FCN-723J-G/AM	FUJITSU LIMITED

Drawing No.	Sheet No.	Revision	6
K6610091	43/43	2005/2/23	